

A material
for life.
Made today,
for the living
of tomorrow.

Making History

WITH IQ GRANIT
& IQ EMINENT

 **Tarkett**

Making History

2

3

Page 06

Best in class performance

Reliable installation

Best in class durability

Hygienic solution for demanding environments

Page 10

True multifunctionality

Acoustic solutions

Anti-slip options

Conductive and dissipative options

Page 14

Iconic design

Adaptable materials

Design story

Page 22

Sustainability at the heart

Good materials

Circular economy

Reducing our carbon footprint

ReMaking History

Making History



iQ Granit and iQ Eminent collections draw on decades of experience and innovation to make them more usable, inspirational and applicable than ever before.

To make history you need to do something pretty special with a human-centric approach.

An impact that can still be felt years, even decades, after the event. In the design landscape few materials have had such a lasting impact as Tarkett homogeneous vinyl, a material as relevant today as it's ever been. iQ Granit & iQ Eminent embody our commitment to stand with present and future generations. To create surfaces that are good for people and for the planet. And to do it every day.

Created 50 years ago, this versatile, humble material is all around us, working peerlessly in schools, workplaces, hospitals, hotels, factories and airports. Homogeneous vinyl is one of the materials that can truly be said to embody function and aesthetics in one seamless package.

The same unbeatable performance, the unique multifunctionality, the new design & colours and leading sustainability credentials.

We make history by remaking history.

Best in class performance

6

iQ Granit and iQ Eminent are ground-breaking ranges that draw on Tarkett's 50 years of experience. Homogeneous vinyl is the iconic, durable, go-to material for architects and designers wanting a performance product that exceeds expectation.

iQ products are made from the very best materials, to contribute to healthy environments. Its compact composition has a strength and longevity capable of withstanding the toughest conditions – one of the reasons it's often found in high-wear situations like hospitals, schools and other social spaces.

The nature of the material allows for perfect installation and reparation, using a unique dry-buffing maintenance and restoration system. Its sealed surface and unique treatment gives best-in-class protection for decades against marks and stains.



iQ Granit Sense
soft white grey
21142 528

iQ Eminent
pale blue
21030 888

iQ Eminent Unisense
dusty white
21030 906

7

iQ Granit
yellow brick
21142 444

iQ Granit Sense
soft white grey
21142 528



These features make iQ Granit and iQ Eminent a desirable, durable and attractive design that's perfectly suited for heavy traffic areas. The use of iQ Granit and iQ Eminent is especially relevant when hygiene and infection prevention are paramount, in applications like health or aged care.

Lifelong performance

Best in class durability



A truly unique **homogeneous 2 mm** construction **lasting for 30 years** and more, based on EPD data.

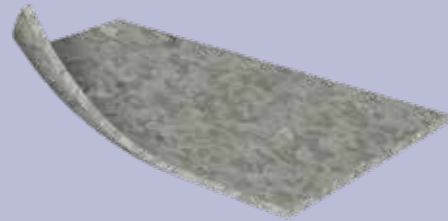

Homogeneous construction



The product offers **outstanding seam strength preventing joints from opening**. Coving and perfectly sealed joints eliminate traps for dirt or dust while offering a watertight finish and enhanced seam strength.



Easy to repair if damage occurs: cut out damaged area, cut replacement piece, heat-weld. Done!



Renewable through our **unique dry-buffing restoration system**. No water, no chemicals, just buff the surface to bring back its original properties and look.

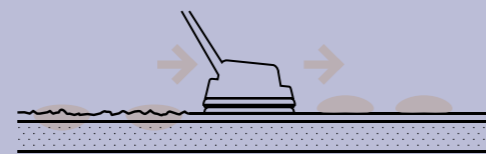

Small surface abrasions from traffic allow stains to penetrate and become embedded

Dry-buffing

Restored flooring after dry-buffing, ensuring a sealed, smooth surface to maximise hygiene



Hygienic solution for demanding environments



The **smooth** surface of the product and its unique **surface treatment** offer an **"excellent cleanability"**, validated by the Fraunhofer Riboflavin test. It is resistant to disinfectants and antiseptics used in healthcare settings (Quaternary ammoniums, Alcohol, Bleach, Hydrogene peroxide,...).



Tests results available on demand on our website.



This high efficiency to cleaning and disinfection protocols designate iQ Granit and iQ Eminent as an **ideal solution to ensure a proper Infection Protection Control**.



The product can be installed in the most demanding environments such as **ISO 4 cleanrooms (ISO14644-1)**.



iQ Granit & iQ Eminent do not favour bacteria growth (according to ISO 846/C) and do not contain any biocide.

Reliable installation



The great **flexibility** of the material ensures perfect covings and hot welding for a water tight seal from floor to wall.



Our technical teams are there to support your project installation. Contact your sales representative for more information & training.



Perfect coving and hot welding

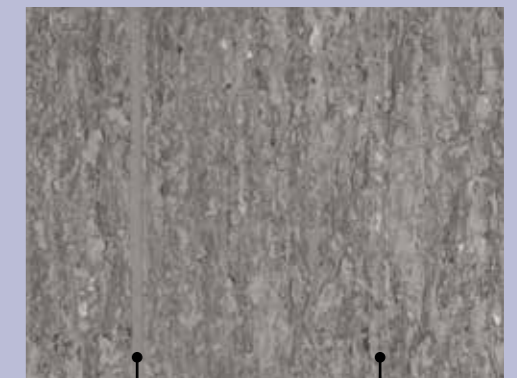

Unicolour welding rod

Multicolour welding rod

Mix and match design with true multifunctionality

10



iQ Granit SafeT
21153 502

11

iQ Granit
white green
21142 338

iQ Granit
light green
21142 390

iQ Eminent
pale brick
21030 895

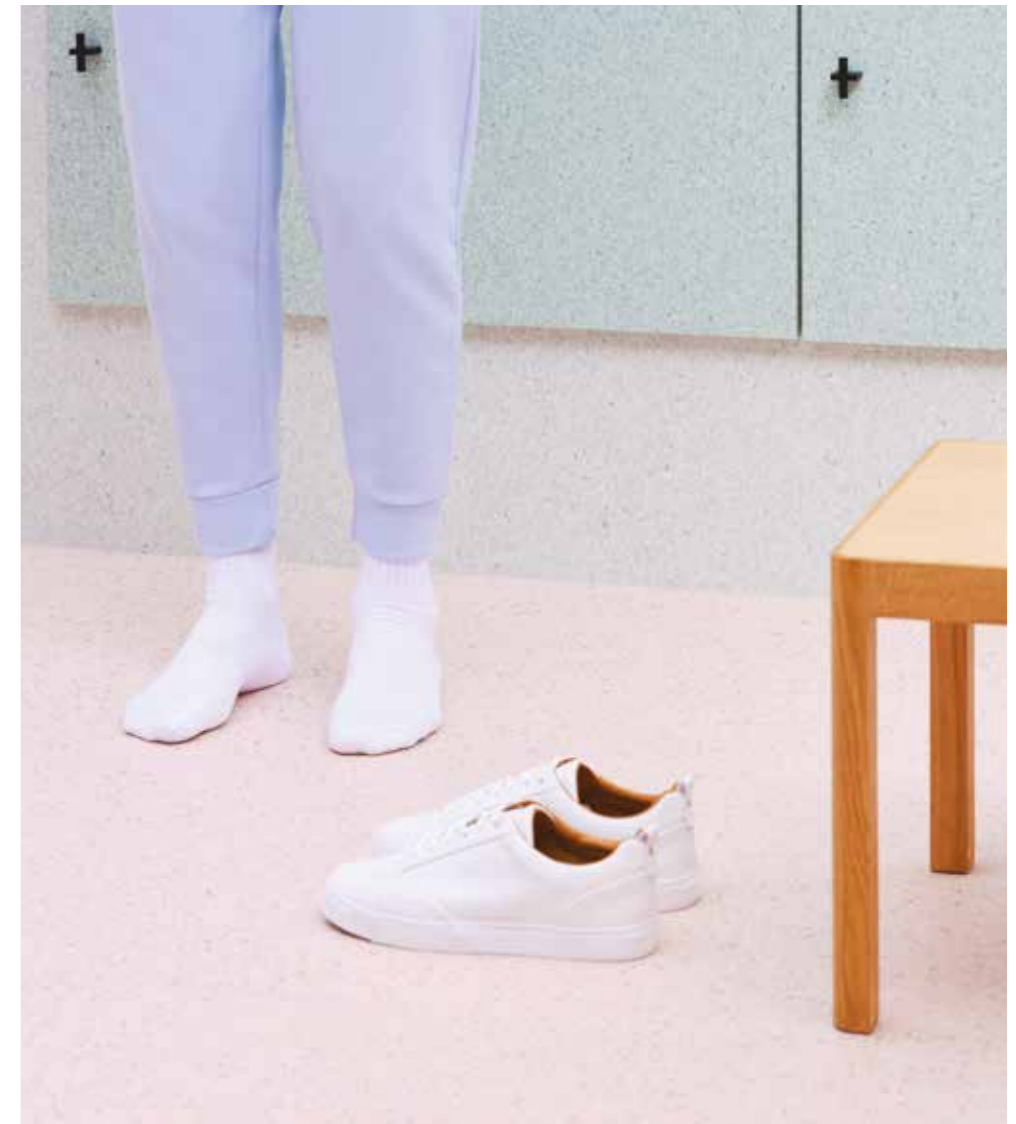

Made for the most demanding of spaces.

Sound reduction to limit noise and ensure better living and working conditions. Like reducing the noise of trolleys in hospital corridors, or toning down ambient noise from areas of heavy traffic.

Slip resistance for both barefoot and shod, specifically in wet areas. Bathrooms, kitchens and entrances, for example, are all sensitive areas.

Reducing static discharge as electrostatic and electrical discharges can be dangerous to people, but can also damage sensitive equipment typically found in operating theatres, radiology rooms or pharmaceutical laboratories. Therefore, reducing the risk of electrostatic discharge is a priority in cleanrooms.

The iQ Granit and iQ Eminent technical ranges cover all these needs – both technically and aesthetically. iQ Granit Acoustic, Granit Safe.T and Multisafe (antislip solutions), iQ Granit SD and iQ Toro SC (static conductive and dissipative) have all been developed to meet the most demanding technical requirements, while keeping aesthetics in mind. 14 core colours (8 for multisafe products) are fully combinable with the iQ Granit & iQ Eminent multi-solution family.

For faster, easier floor planning, and contributing to the well-being of everyone who uses these spaces.

Unique mix and match technical options

12

13

Acoustic solutions



Where noise needs to be controlled, iQ Granit Acoustic offers a reduction of 15dB. With its 2mm wear layer and its PVC backing, our acoustic solution offers the same durability as the compact version.

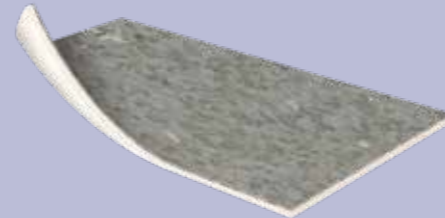

Acoustic PVC backing construction

Anti-slip options



Granit Safe.T offers a unique construction where **particles are embedded through the whole construction of the product** (according to DIN EN 13845). This ensures its anti-slip qualities to make safety last for decades.



Granit Multisafe has a **studded anti-slip grip** providing a high level of protection for bare feet, even when the floor is covered with soap and water.

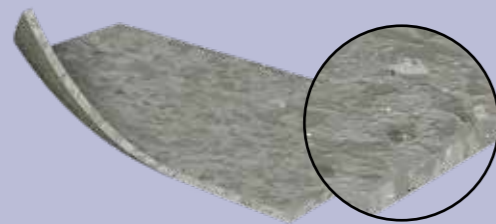

Embedded particules

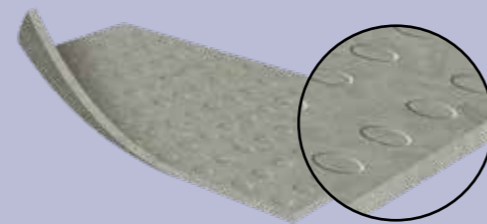

Anti-slip studs

Conductive and dissipative options



iQ Granit SD has an electrical resistance of $R_1 \leq 10^8 \Omega$ (EN 1081).



iQ Toro SC has a resistance between R_1 $5 \times 10^4 \Omega$ and $10^6 \Omega$ (EN1081).

Both comply with European standard EN 1815 on electrostatic propensity.

With their specific construction, those two products are the best solution for technical spaces. **Conductive fibers are dispersed through the whole construction** (physically dissipative instead of chemically), so **the effect will last over the product's lifespan**. And it allows dry-buffing to keep its lustre. The 'treatment' does not migrate and is not humidity sensitive.

Each offers great ease of installation, as a result of their unique carbon backing, which is static-conductive. So the need for conductive adhesive glue during installation is eliminated (except over copper strip).

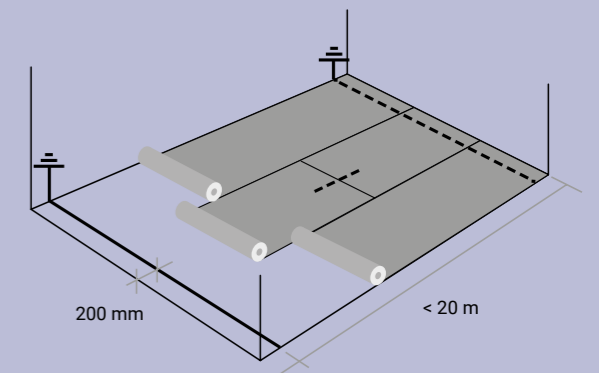

Build tomorrow's caring spaces on a foundation of creativity and function

14



iQ Granit
dark blue
21142 339

iQ Granit
light blue
21142 341

iQ Eminent Unisense
dusty beige
21030 998

iQ Eminent Unisense
dusty brick
21030 999

15

The new iQ Granit and iQ Eminent collections contribute to a new way of creating spaces that care for human needs. Soothing, kind and inspiring, for the next generation of social spaces.

iQ Granit and iQ Eminent offer 4 patterns and a complete new colour story. A recipe to fit all rooms while creating new harmonies and ensuring inclusive design, with a particular focus on designing for dementia. And the story doesn't stop there, where technical solutions are required iQ Granit Acoustic, iQ Toro SC, iQ Granit SD and Granit Safe.T offer the same fresh colours and work perfectly with iQ Granit and iQ Eminent.

iQ Granit showcases a new design. While preserving the unique Granit character, it now features a contemporary and modern touch, with a craftsmanship design and soft warm living texture. Classical colours have been lightened to provide a fresh and modern harmony that sit perfectly with iQ Eminent.

With its beautiful honed and polished natural stone design, **iQ Eminent** provides a new tonal palette with a sophisticated and rich touch. Both muted and bold, this collection supports biophilic design and allows for spaces to be created with well-being in mind.

Designed for creative freedom with the different patterns and colours, the collections are divided in to 4 colour families which are easy to combine but also beautiful on their own.

Oxide, the reddish tones and cold beige neutrals
Argil, the yellowish tones and warm beige neutrals
Lichen, the greenish tones and warm grey neutrals
Basalt, the blueish tone and cold grey neutrals

iQ Granit Sense
soft white grey
21142 528

iQ Eminent
pale blue
21030 888

iQ Eminent Unisense
dusty white
21030 906





iQ Granit
white green
21142 338

iQ Granit
light green
21142 390

iQ Eminent
pale brick
21030 895



Granit Safe.T
21153 502

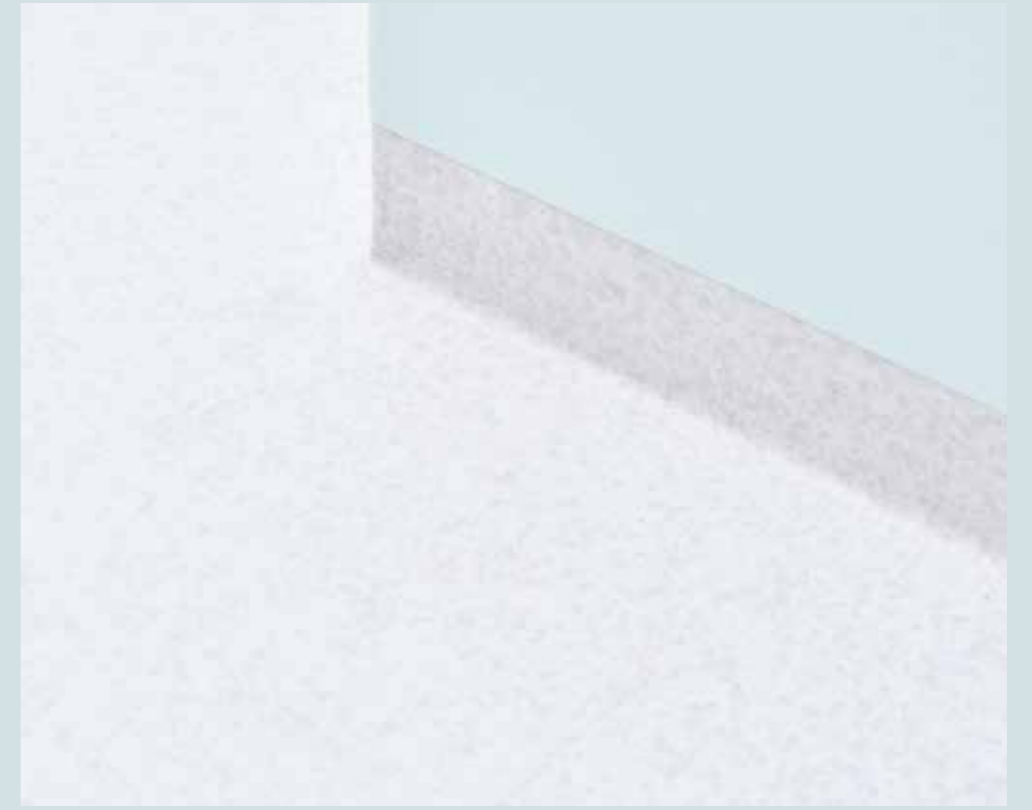

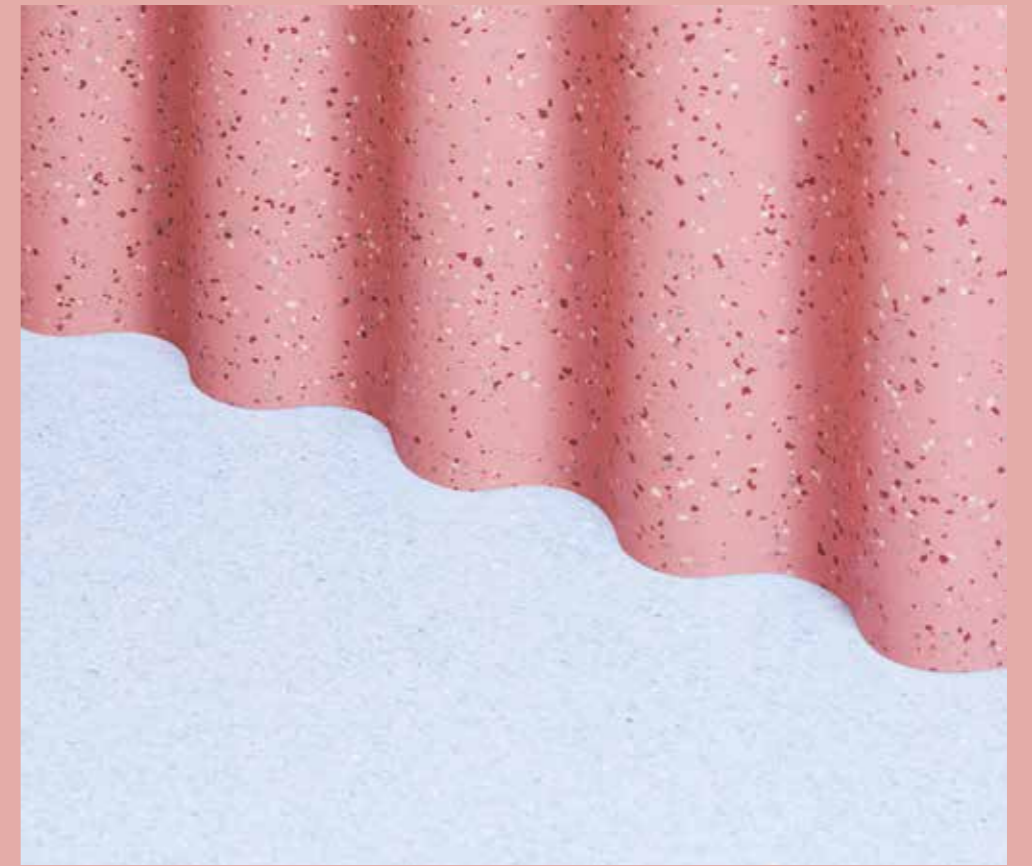

iQ Granit
light blue
21142 341

iQ Eminent Unisense
dusty beige
21030 998

iQ Eminent Unisense
dusty brick
21030 999



iQ Granit
yellow brick
21142 444

iQ Eminent
pale yellow
21030 894



Oxide, the reddish tones and cold beige neutrals

iQ Granit



iQ Granit Sense



iQ Eminent



iQ Eminent Unisense

Basalt, the blueish tone and cold grey neutrals

iQ Granit

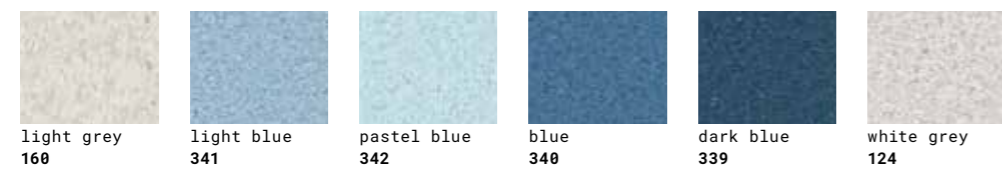

iQ Granit Sense



iQ Eminent

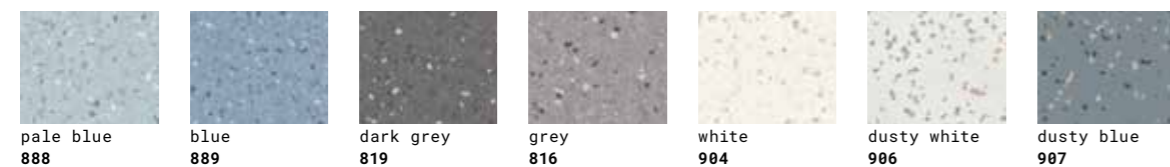

iQ Eminent Unisense

Argil, the yellowish tones and warm beige neutrals

iQ Granit



iQ Granit Sense



iQ Eminent



iQ Eminent Unisense

Lichen, the greenish tones and warm grey neutrals

iQ Granit

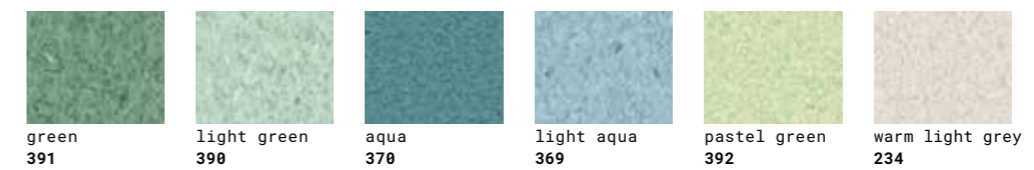

iQ Granit Sense



iQ Eminent

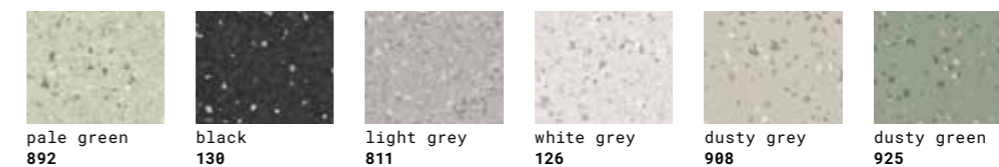

iQ Eminent Unisense

ReMaking History



We use the things we've learned in the past to make huge leaps into the future.

Caring for people and the planet is in our roots

At Tarkett, we're committed to a sustainable, circular economy that creates value for everyone, closing the loop on waste, preserving natural resources and reducing our impact on climate change.

From our base in Ronneby, Sweden, we're infusing these collections with all the sustainable innovation at our disposal to extend the life of each product, remaking history for the present and the futures to come. Homogeneous vinyl as a concept was born here 50 years ago, with the idea to give people the best materials to improve life while being respectful to our world and its resources.

Today, we remake it into something even better for people and the planet.

A good journey

To create a material around the principles of sustainability, the entire product life cycle is taken into account.



24

25



Begin with good materials:

Our materials are created with the health and sustainability standards of the Cradle to Cradle® principles. This means investing in materials with green credentials that actively contribute to healthier environments. iQ Granit and iQ Eminent use phthalate free plasticisers, do not contain biocides and emit extremely low emissions of volatile organic compounds (VOCs) for indoor air quality. Their impact on health have been independently assessed by an external laboratory named EPEA and the results are available in MHSs (Material Health Statements). They show not to pose any health concern. Moreover, the physical construction of our products and their maintenance enable a lengthened lifespan. Those are key factors in moving towards a sustainable future. Our environmental and ethical standpoints are fully outlined in our EPDs (Environmental Product Declaration).

Sustainable production:

One key area of focus is making our manufacturing processes as carbon efficient as possible.

Our iQ Granit and iQ Eminent are produced in our Ronneby plant where 100% of the energy consumption comes from renewable energies.

Our production works with 99,5% in close loop for water and generates 0% waste to landfill. The plant is also certified ISO14001 (Environment) and 500001 (Energy).

Recycle:

Recycling is one of the cornerstones of our circular economy initiatives as we are committed to reducing our impact on a resource level. iQ Granit and iQ Eminent already contain an average of 25% recycled content. Our aim is to take that to 30% on all our products by 2030. To achieve this goal, we're using a complete recycling scheme where production, installation and post-use floorings are taken back into production to make new floors.

Circular innovation to reduce our carbon footprint

26

27

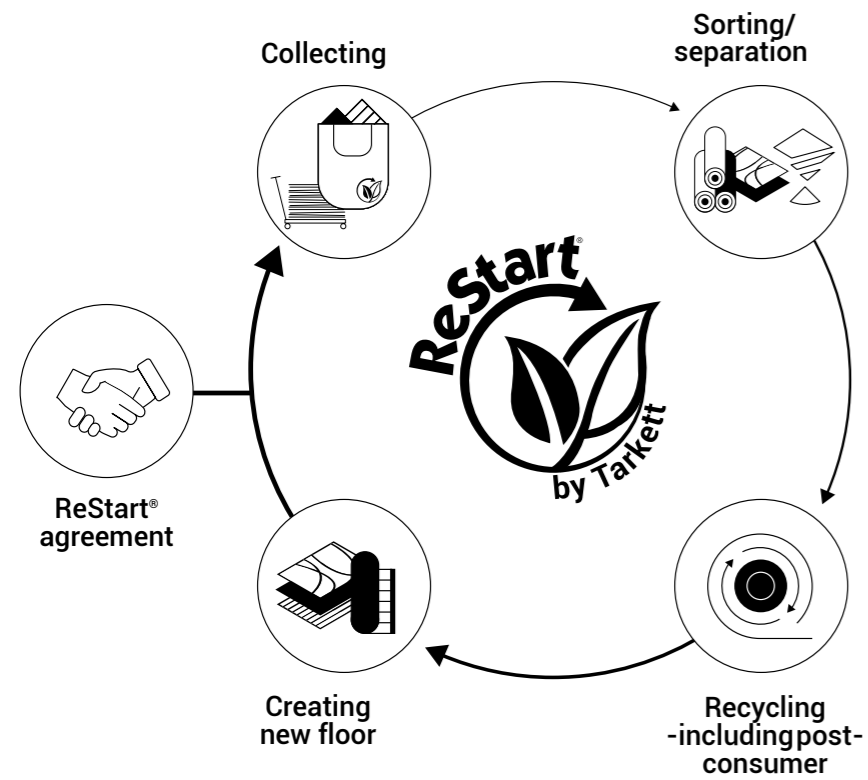

The renewed iQ Granit and iQ Eminent collections are forged in the principles of the circular economy - close the loop with us to foster our sustainability impact.

Post-use recycling

You can work towards achieving higher levels of sustainability and green building labels like LEED, WELL and BREEAM by using iQ Granit and iQ Eminent in your projects. Our innovation teams developed a unique solution to recycle phthalate-free postconsumer homogeneous vinyl flooring. Using specialist material and acustomised processes, we are able to separate and clean the vinyl material from any glue or concrete residues, creating granules that can be integrated into the production of new homogeneous flooring at our plant in Ronneby, Sweden.

Our ReStart® take-back programme saves resources and energy to increase the level of recycling content of our product.

Recycling 1m² of iQ homogeneous vinyl saves 11,8kg CO₂eq/m².

Assesment validated by ivl, the swedish environmental research institute.

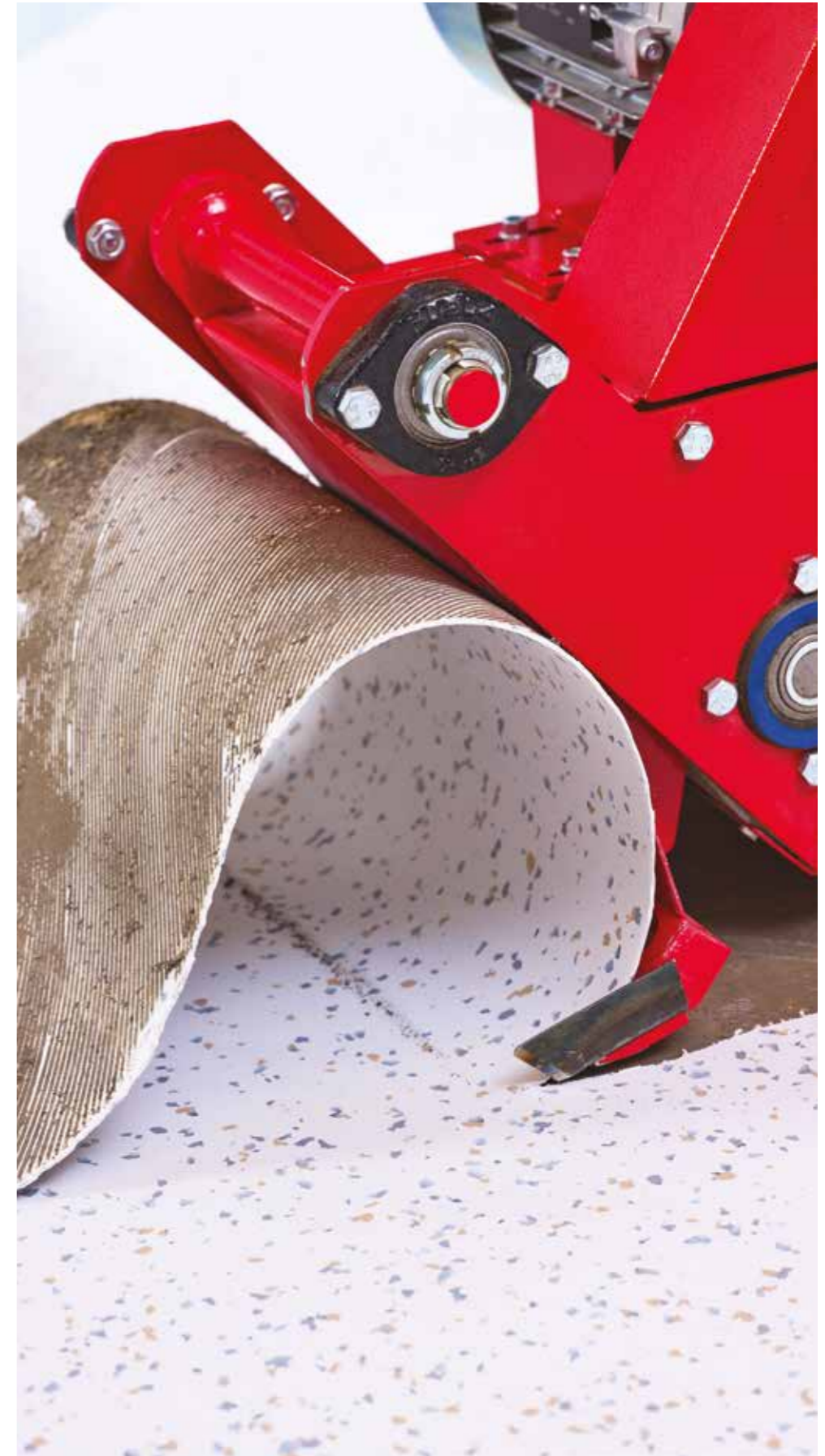

Circular economy in action: in 2020 the Ikea store in Kungens Kurva underwent a significant renovation, we took back 10,000m² of the old floor and sent it to our factory in Ronneby to be recycled. This provided a saving of 100 tonnes of CO₂ emissions.

You can take one more step towards reducing our carbon footprint

28

29

Take advantage of the opportunity to go the extra mile and reduce our planet's net carbon footprint.

On demand, we can produce iQ Granit and iQ Eminent with bio-attributed vinyl, under the mass balance principles, for a greatly reduced carbon footprint.

We use bio-attributed vinyl - Biovyn™ - replacing fossil-sourced raw material with renewable biomass, that comes from wood residue, supplied from sustainable forests from Finland, not competing with food production.

Mass balance is a calculation method that guarantees that the amount of bio-based output from the process is equal to the bio-based input. This calculation method is based on an RSB (the Roundtable on Sustainable Biomaterials) standard and certified by an external party, SCS, to ensure total tracking and transparency.

iQ Granit and iQ Eminent products made with bio-attributed vinyl keep the same technical and maintenance high quality properties as the standard version. And it can be taken back after use and recycled into new products.

iQ Granit and iQ Eminent with bio-attributed vinyl offer an increased* greenhouse gas emission reduction versus the standard iQ Granit and iQ Eminent ranges. It's a groundbreaking development that takes us one step further to a carbon neutral society.

*Check our updated EPDs on our website.

Please contact your local sales rep to request this product.

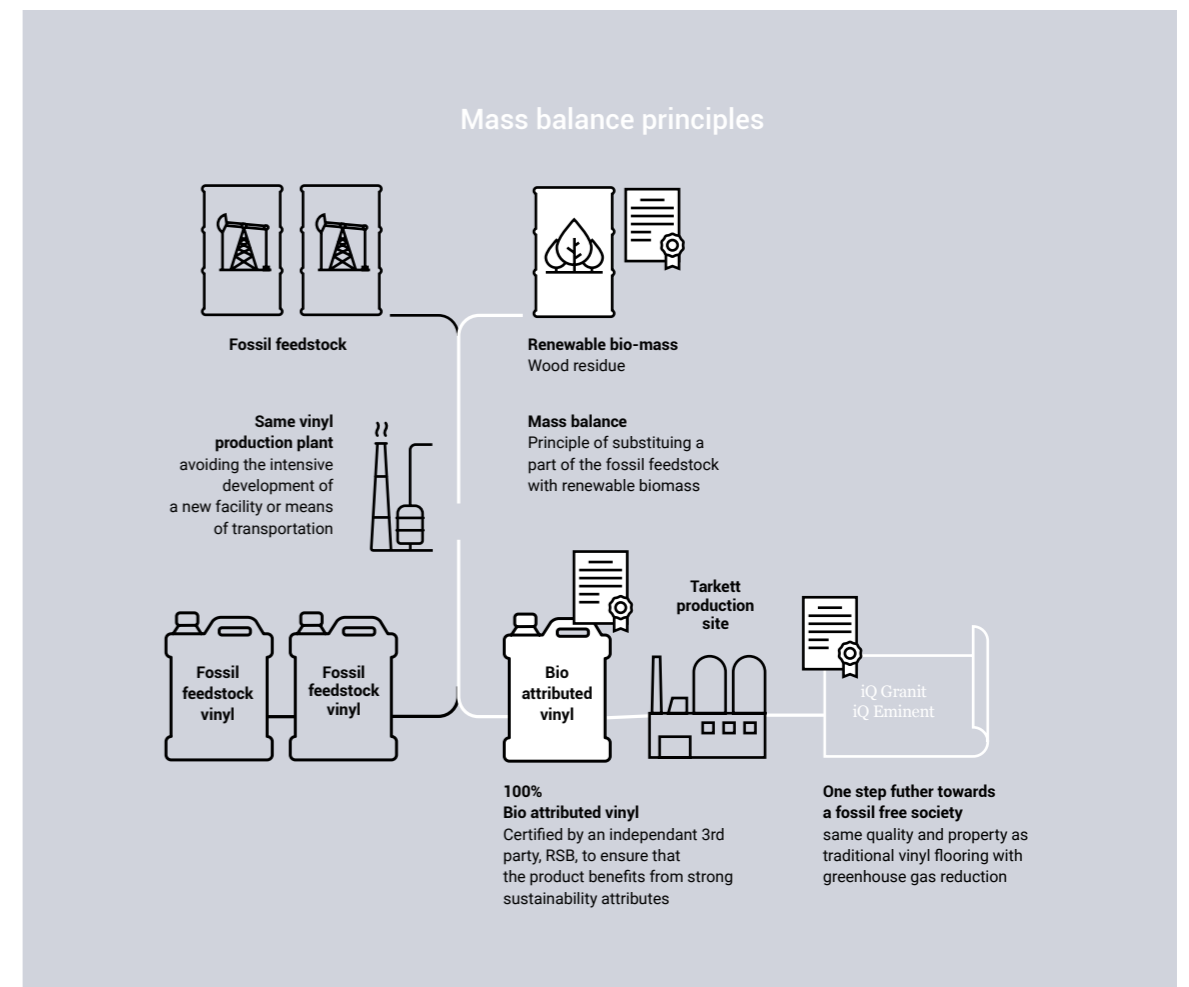

iQ Granit Roll	iQ Granit Tiles	Welding rod		NCS	LRV	iQ Granit Acoustic	iQ Toro SC	iQ Granit SD	Granit Safe.T	Granit Multisafe
		unicolour	multicolour							
21142 124	21143 124	1287 522	1290 167	S 2002-R50B	56%	—	—	—	—	—
21142 160	21143 160	1287 411	1290 283	S 1500-N	65%	21155 160	3093 100	3096 395	21153 502	—
21142 161	21143 161	1287 630	1290 286	S 2500-N	50%	21155 161	3093 101	3096 948	21153 503	—
21142 188	21143 188	1292 383	1290 021	S 4502-B	29%	21155 188	3093 102	3096 949	21153 504	—
21142 194	21143 194	1287 842	1290 412	S 6502-B	15%	21155 194	3093 578	3096 950	21153 505	—
21142 211	21143 211	1291 933	1290 035	S 8502-B	6%	21155 211	3093 103	3096 953	21153 506	—
21142 215	21143 215	1287 832	1290 358	S 6000-N	19%	21155 215	—	—	—	—
21142 233	21143 233	1287 789	1290 340	S 3500-N	39%	21155 233	—	—	—	—
21142 234	21143 234	1287 279	1290 250	S 1502-Y	65%	—	—	—	—	—
21142 296	21143 296	1292 770	1290 420	S 2502-Y	50%	21155 296	—	—	—	—
21142 297	21143 297	1287 693	1290 427	S 4502-Y	29%	21155 297	—	—	—	—
21142 298	21143 298	1287 797	1290 424	S 1510-Y30R	61%	21155 298	3093 957	3096 468	21153 511	21154 469
21142 320	21143 320	1287 773	1290 374	S 2005-Y30R	56%	—	—	—	21153 520	—
21142 321	21143 321	1287 830	1290 361	S 4005-Y20R	33%	21155 321	3093 955	3096 436	21153 508	—
21142 322	21143 322	1287 391	1290 143	S 3010-Y30R	41%	21155 322	3093 956	3096 467	21153 509	—
21142 323	21143 323	1287 069	1290 422	S 1505-Y30R	64%	21155 323	—	—	21153 507	—
21142 324	21143 324	1287 930	1290 255	S 3010-Y50R	41%	21155 324	—	—	—	—
21142 325	21143 325	1287 773	1290 036	S 1505-Y50R	63%	21155 325	3093 104	3096 954	21153 512	—
21142 328	21143 328	1292 393	1290 248	S 2005-Y50R	54%	21155 328	—	—	—	—
21142 329	21143 329	1287 291	1290 343	S 3005-Y50R	40%	21155 329	3093 958	3096 474	21153 513	21154 470
21142 330	21143 330	1291 847	1290 375	S 4005-Y50R	31%	—	—	—	—	—
21142 337	21143 337	1287 458	1290 344	S 6005-Y50R	18%	—	—	—	—	—
21142 338	21143 338	1287 942	1290 431	S 2005-G	54%	21155 338	3093 959	3096 475	21153 514	21154 471
21142 339	21143 339	1287 594	1290 414	S 6020-R90B	11%	—	—	—	21153 521	—
21142 340	21143 340	1287 281	1290 273	S 4030-R90B	20%	—	—	—	21153 515	21154 472
21142 341	21143 341	1287 803	1290 425	S 2020-R90B	44%	21155 341	3093 960	3096 476	21153 516	—
21142 342	21143 342	1287 939	1290 434	S 1015-B	63%	—	—	—	—	—
21142 369	21143 369	1287 509	1290 107	S 2020-B10G	44%	21155 369	3093 961	3096 980	21153 517	21154 473
21142 370	21143 370	1287 940	1290 433	S 4020-B30G	25%	—	—	—	21153 523	—
21142 390	21143 390	1287 875	1290 413	S 2010-G	52%	21155 390	3093 966	3096 994	21153 518	—
21142 391	21143 391	1287 937	1290 410	S 4020-G10Y	30%	—	—	—	—	—
21142 392	21143 392	1287 938	1290 411	S 1020-G40Y	64%	—	—	—	—	—
21142 412	21143 412	1287 332	1290 280	S 3020-G40Y	37%	21155 412	—	—	—	—
21142 438	21143 438	1287 357	1290 215	S 2020-G80Y	52%	—	—	—	—	—
21142 439	21143 439	1288 363	1290 418	S 1020-Y10R	68%	—	—	—	—	—
21142 440	21143 440	1287 359	1290 428	S 1040-Y20R	60%	—	—	—	—	—
21142 444	21143 444	1291 772	1290 039	S 2020-Y30R	50%	21155 444	—	—	—	—
21142 456	21143 456	1287 894	1290 415	S 2040-Y60R	35%	—	—	—	—	—
21142 457	21143 457	1287 941	1290 432	S 1020-Y70R	59%	—	—	—	—	—
21142 458	21143 458	1287 936	1290 409	S 3030-Y70R	29%	21155 458	—	—	—	—
21142 525	21143 525	1288 376	1290 416	S 3050-Y80R	18%	—	—	—	—	—
21142 526	21143 526	1287 910	1290 419	S 2020-R20B	43%	—	—	—	—	—
iQ Granit Sense										
21142 527	21143 527	1287 944	—	1002-Y50R	74%	—	—	—	—	21154 123
21142 528	21143 528	1287 446	—	S 1500-N	65%	—	—	—	—	—
21142 554	21143 554	1291 811	—	S 2500-N	50%	—	—	—	21153 524	—
21142 579	21143 579	1287 692	—	S 4000-N	34%	—	—	—	—	21154 896
21142 627	21143 627	1287 842	—	S 5502-B	21%	—	—	—	—	21154 901
21142 636	21143 636	1294 727	—	S 6500-N	16%	—	—	—	21153 519	—
21142 752	21143 752	1287 546	—	S 6005-Y20R	18%	—	—	—	—	—
21142 755	21143 755	1287 458	—	S 6005-Y50R	18%	—	—	—	—	—

iQ Eminent Roll	iQ Eminent Tiles	Welding rod		NCS	LRV
		unicolour	multicolour		
21030 126	21031 126	1287 703	1290 243	S 1500-N	65%
21030 130	21031 130	1292 384	1290 034	S 8500-N	6%
21030 811	21031 811	1292 859	1290 426	S 3000-N	45%
21030 816	21031 816	1287 730	1290 170	S 4500-N	30%
21030 819	21031 819	1287 832	1290 429	S 6000-N	19%
21030 870	21031 870	1287 840	1290 338	S 5502-Y	22%
21030 878	21031 878	1287 839	1290 365	S 4502-Y	29%
21030 879	21031 879	1292 770	1290 244	S 2502-Y	50%
21030 883	21031 883	1287 637	1290 248	S 2005-Y20R	56%
21030 885	21031 885	1288 255	1290 025	S 1505-Y40R	63%
21030 887	21031 887	1287 291	1290 249	S 3005-Y50R	40%
21030 888	21031 888	1287 678	1290 321	S 2010-R90B	52%
21030 889	21031 889	1287 734	1290 417	S 3020-B	32%
21030 892	21031 892	1287 701	1290 423	S 2010-G50Y	54%
21030 894	21031 894	1287 041	1290 045	S 1020-Y20R	65%
21030 895	21031 895	1287 943	1290 430	S 2010-Y70R	52%
21030 904	21031 904	1287 338	1290 193	S 1002-Y50R	74%
21030 905	21031 905	1287 665	1290 421	S 5030-Y70R	15%
iQ Eminent Unisense					
21030 906	21031 906	1287 411	—	S 1500-N	65%
21030 907	21031 907	1287 934	—	S 5010-B10G	22%
21030 908	21031 908	1287 290	—	S 2502-Y	50%
21030 925	21031 925	1287 935	—	S 4010-G30Y	30%
21030 928	21031 928	1287 695	—	S 2005-Y30R	56%
21030 939	21031 939	1287 700	—	S 3020-Y20R	37%
21030 998	21031 998	1287 698	—	S 1505-Y50R	63%
21030 999	21031 999	1287 933	—	S 4020-Y80R	24%

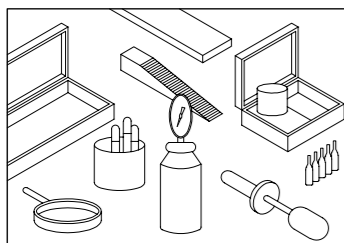

1. SUBFLOOR CONTROL

- The subfloor must be clean, hard, flat and free from all types of marks, debris & residues, and not exposed to humidity.
- Damp proofing to be carried out according to local building standards.
- When installing this product on concrete subfloors that do not include damp-proofing, the moisture content measured in terms of relative humidity must not be higher than 85% (in UK and Ireland 75% according to BS 8203). Or less than 2% with CM (Carbide Method).
- Refer to local standards for detailed rules and control methods.
- Stop underfloor heating for a minimum of 48hrs before installation and maintain the temperature in the room with an alternative heating source. Remain turned off for 6-7 days and then ramped up.

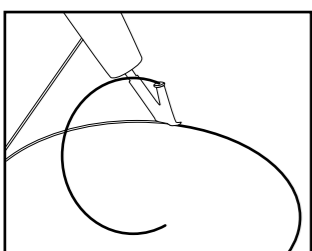

4. HOT WELDING

- The sheets are hot welded. Do not weld until the adhesive has bonded completely, wait 24-48hrs. The joints are chamfered or grooved to about 3/4 of the thickness using a hand grooving tool or machine prior to welding.
- Weld with hot-air and Tarkett Speed Welding Nozzle. Welded seams must cool to room temperature before trimming in two steps, rough and fine trimming.

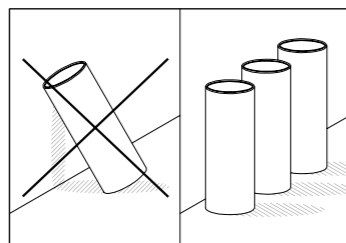

2. BEFORE INSTALLATION

- Store the rolls upright in a safe position with distance between the rolls.
- Prior to laying, allow the material, adhesive and subfloor to reach room temperature, i.e. a temperature of at least 15°C. The relative air humidity should be 30-60%. Rolls must be stored indoors at least 24 hours before installation, preferable 48 hours.
- Installation should be carried out at room temperature between 18°C to 26°C. Subfloor temperature must be at least 15°C. The relative air humidity in the premises should be 35-65%. Maintain same temperature and humidity for at least 72 hours after installation.
- If material from several rolls is used, they should have the same manufacturing serial numbers and be used in consecutive order.

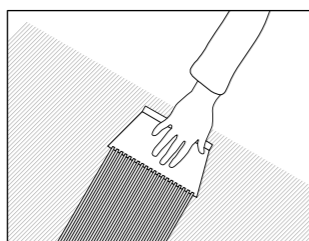

5. AFTER INSTALLATION

- Always protect the floor with thick paper, hard board or similar during the construction period. If using tape, this must not be applied directly to the floor surface.

IMPORTANT!

Restrict foot traffic for 24 hours after installation. No heavy traffic, rolling loads or furniture placement for 72 hours after installation. Most suppliers of floor adhesives specify 72 hours before the final strength is achieved.

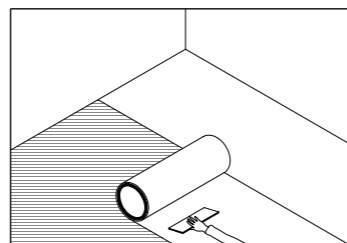

3. ROLL INSTALLATION

- Cut the sheets to length and lay them out to acclimatise and relax prior to installation. This is particularly important for longer lengths.
- Sheets must be installed so that colour differences are avoided. Reverse sheets whenever possible, overlap and cut edges.
- The sheets are fully adhered with an adhesive approved for Tarkett's homogeneous vinyl sheet, spatula A1/A2. See the adhesive manufacturer's instruction regarding coverage, open time etc. Example of suitable adhesives can be found at professionals.tarkett.com
- Rub the face surface down thoroughly to ensure that the floor covering makes good contact with the adhesive and that all air is expelled. Make sure that the tool used for rubbing down the floor covering does not scratch the surface. A broom is not suitable for this purpose. Use a floor roller (approx. 65 kg) and roll crosswise over the floor.



CERTIFICATION & CLASSIFICATION	STANDARDS	iQ Granit
Type of floor covering	ISO 10581	Homogeneous single layered vinyl flooring
Declaration of performance	EN 14041	0019-0009-DoP-2013-07
Binder content	ISO 10581	Type I
Classification	ISO 10874	Commercial: 34 Industrial: 43
Recyclable	EN 14021	Yes, post installation and post use

TECHNICAL CHARACTERISTICS

Surface treatment		iQ
Surface restoration		Yes
Total thickness	ISO 24346	2.0 mm
Wear layer thickness	ISO 24340	2.0 mm
Total weight	ISO 23997	2750 g/m ²
Form of delivery iQ Granit	ISO 24341 Sheet (rolls) ISO 24342 Tiles (box)	Approx. 25 running metres x 200 cm Art. no. 21142_ _ _ 3 digit colour number 61.0 x 61.0 cm – 14 tiles/box = 5.21 m ² Art. no. 21143_ _ _ 3 digit colour number
Form of delivery iQ Granit bio-attributed	ISO 24341 Sheet (rolls) ISO 24342 Tiles (box)	Approx. 25 running metres x 200 cm Art. no. 21144_ _ _ 3 digit colour number 61.0 x 61.0 cm – 14 tiles/box = 5.21 m ² Art. no. 21145_ _ _ 3 digit colour number

TECHNICAL PERFORMANCES

Reaction to fire	EN 13501-1 EN ISO 9239-1 EN ISO 11925-2	Class B _{f1} s1 ≥ 8 kW/m ² Pass
Marine equipment	IMO FTPS Part 5 and 2 IMO Res. A653	
Residual indentation	ISO 24343-1	Required value: ≤ 0.10 mm Best measured value: 0.02 mm
Castor chair test	ISO 4918	Suitable
Static electrical discharge	EN 1815 On any surface ≤ 10 ⁹ Ω	< 2 kV
Clean room	ISO 14644-1	ISO class 4
Riboflavin test	Fraunhofer method	Class 0: Excellent
Total VOC emissions	ISO 16000-6 Indoor air quality FloorScore	≤ 10 µg/m ³ (after 28 days) Platinum SCS certified
Underfloor heating		Suitable – max 27°C
Light fastness	EN ISO 105-B02	≥ level 7
Ease of decontamination	ISO 8690 – DIN 25415	Excellent
Chemical resistance	ISO 26987	Excellent
Bacteria resistance	ISO 846:Part C	Does not favour growth
Slip resistance	DIN 51130 EN 13893 BS 7976-2	R9 ≥ 0.3 Low risk of slip
Wet room approval	EN 13553 Annex A	Watertight

COLOURS

50

The above information is subject to modification for the benefit of further improvement (04/2021).

According to the European Regulation N° 305/2011 for CE Marking, the Declarations of Performance are available on our website www.tarkett.com

Tarkett's instructions regarding installation, cleaning and maintenance should be observed. Please contact Tarkett at the address shown for these instructions.

Customs Tariff: 4820500000



CERTIFICATION & CLASSIFICATION	STANDARDS	iQ Eminent
Type of floor covering	ISO 10581	Pressed homogeneous single layered vinyl flooring
Declaration of performance	EN 14041	0019-0008-DoP-2013-07
Binder content	ISO 10581	Type I
Classification	ISO 10874	Commercial: 34 Industrial: 43
Recyclable	EN 14021	Yes, post installation and post use

TECHNICAL CHARACTERISTICS

Surface treatment		iQ
Surface restoration		Yes
Total thickness	ISO 24346	2.0 mm
Wear layer thickness	ISO 24340	2.0 mm
Total weight	ISO 23997	2750 g/m ²
Form of delivery iQ Eminent	ISO 24341 Sheet (rolls) ISO 24342 Tiles (box)	Approx. 23 running metres x 200 cm Art. no. 21030_ _ _ 3 digit colour number 61.0 x 61.0 cm – 14 tiles/box = 5.21 m ² Art. no. 21031_ _ _ 3 digit colour number
Form of delivery iQ Eminent bio-attributed	ISO 24341 Sheet (rolls) ISO 24342 Tiles (box)	Approx. 23 running metres x 200 cm Art. no. 21146_ _ _ 3 digit colour number 61.0 x 61.0 cm – 14 tiles/box = 5.21 m ² Art. no. 21147_ _ _ 3 digit colour number

TECHNICAL PERFORMANCES

Reaction to fire	EN 13501-1 EN ISO 9239-1 EN ISO 11925-2	Class B _{f1} s1 ≥ 8 kW/m ² Pass
Residual indentation	ISO 24343-1	Required value: ≤ 0.10 mm Best measured value: 0.02 mm
Castor chair test	ISO 4918	Suitable
Static electrical discharge	EN 1815 On any surface ≤ 10 ⁹ Ω	< 2 kV
Clean room	ISO 14644-1	ISO class 4
Riboflavin test	Fraunhofer method	Class 0: Excellent
Total VOC emissions	ISO 16000-6 Indoor air quality FloorScore	≤ 10 µg/m ³ (after 28 days) Platinum SCS certified
Underfloor heating		Suitable – max 27°C
Light fastness	EN ISO 105-B02	≥ level 7
Ease of decontamination	ISO 8690 – DIN 25415	Excellent
Chemical resistance	ISO 26987	Excellent
Bacteria resistance	ISO 846:Part C	Does not favour growth
Slip resistance	DIN 51130 EN 13893 BS 7976-2	R9 ≥ 0.3 Low risk of slip
Wet room approval	EN 13553 Annex A	Watertight

COLOURS

26

The above information is subject to modification for the benefit of further improvement (04/2021).

According to the European Regulation N° 305/2011 for CE Marking, the Declarations of Performance are available on our website www.tarkett.com

Tarkett's instructions regarding installation, cleaning and maintenance should be observed. Please contact Tarkett at the address shown for these instructions.

Customs Tariff: 4820500000



Human-Conscious Design®

Tarkett Human-Conscious Design® is our pledge to stand with present and future generations. To create flooring and sports surfaces that are good for people and for the planet. And to do it every day.

We deliver on this through the synergy of three commitments:

1. Deep human understanding
2. Conscious choices. For people and planet
3. With you. Every step of the way

■ **WESTERN EUROPE:** Austria: Tarkett Holding GmbH, Niederlassung Wien – Tel. +43 1 47 88 062 ■ **Belgium:** Tarkett Belux Sprl – Tel. +32 52 26 24 11 ■ **Denmark:** Tarkett A/S – Tel. +45 43 90 60 11 ■ **Finland:** Tarkett Oy – Tel. +358 9 4257 9000 ■ **France:** Tarkett SAS – Tel. +33 1 41 20 42 49 ■ **Germany:** Tarkett Holding GmbH – Tel. +49 62 33 810 ■ **Greece:** Tarkett Monoprosopi Ltd – Tel. +30 210 6745 340 ■ **Italy:** Tarkett S.p.A. – Tel. +39 0744 7551 ■ **Luxembourg:** Tarkett GDL SA – Tel. +352 949 211 8804 ■ **Netherlands:** Tarkett BV – Tel. +31 416 685 491 ■ **Norway:** Tarkett AS – Tel. +47 32 20 92 00 ■ **Portugal:** Tarkett SA – Tel. +351 21 427 64 20 ■ **Spain:** Tarkett Floors S.L. – Tel. +34 91 358 00 35 ■ **Sweden:** Tarkett Sverige AB – Tel. +46 771 25 19 00 ■ **Switzerland:** Tarkett Holding GmbH – Tel. +41 043 233 79 24 ■ **Turkey:** Tarkett Aspen – Tel. +90 212 213 65 80 ■ **United Kingdom:** Tarkett Ltd – Tel. +44 (0) 1622 854 040 ■ **EASTERN EUROPE:** **Baltic Countries:** Estonia: Tel. +372 55515880 – Latvia: Tel. +37126112014 – Lithuania: Tel. +370 37 262220 ■ **Czech Republic:** Tarkett org. slozka – Tel. +420 271 001 600 ■ **Hungary:** Tarkett Polska SP Z.O.O. magyarországi fióktelepe – Tel. +36 1 437 8150 ■ **Poland:** Tarkett Polska Sp. z o. o. – Tel. +48 22 16 09 231 ■ **Russian Federation:** ZAO Tarkett RUS – Tel. +7 495 775 3737 ■ **Slovakia:** Tarkett Polska, organizačná zložka – Tel. +421 2 48291 317 ■ **South East Europe:** Tarkett SEE – Tel. +381 21 7557 649 (44) 569 12 21 ■ **Ukraine:** Tarkett UA – Tel. +38 (0) 44 35 45 621 ■ **ASIA AND OCEANIA:** Australia: Tarkett Australia Pty Ltd – Tel. +61 2 88 53 12 00 ■ **China:** Tarkett Floor Covering (Shanghai) Co. Ltd. – Tel. +86 (21) 60 95 68 38 ext 841 ■ **North East Asia:** Tarkett Hong Kong Limited – Tel. +852 2511 8716 ■ **India:** Tarkett Flooring India Pvt. Ltd. – Bangalore – Tel. +91 80 4130 3793 – New Delhi – Tel. +91 11 4352 4073 – Mumbai – Tel. +91 22 2648 8750 ■ **South East Asia:** Tarkett Flooring Singapore Pte. Ltd. – Tel. +65 6346 1585 ■ **AFRICA:** Tarkett International: Tel. +33 1 41 20 41 01 ■ **MIDDLE EAST:** Tarkett Middle East: Tel. +961 1 51 3363/4 ■ **Israel:** Tarkett International: Tel. +33 1 41 20 41 01 ■ **NORTH AMERICA:** **USA:** Tarkett Inc. – Tel. +1 713 869 5811 / Johnsonite – Tel. +1 440 543 8916 ■ **Canada:** Tarkett Inc. – Tel. +1 450 293 173 ■ **LATIN AMERICA:** **Brazil:** Tarkett – Tel. 55 12 3954 7108 ■ **Argentina - Chile - Uruguay:** Tarkett Latam Mercosur – Tel. +54 11 47 08 07 72 / +54 9 11 44 46 88 82 ■ **Bolivia - Colombia - Ecuador - Panama - Paraguay - Peru - Trinidad and Tobago - Venezuela:** Tarkett – Tel. +55 11 9 8410 9310 / +55 11 95494 0069 ■ **Mexico /Central America:** Tarkett Latam Mexico – Tel. +55 11 98410 9310

SAP 3100030045

The designs and photos used in this brochure are for illustration purposes only. They are not contractual images and do not stand for product recommendation. Design/Photo: Note Design Studio / Print: Altavia

professionals.tarkett.com

